

# UNDIS<sup>®</sup>

ALL FOR HEALTH

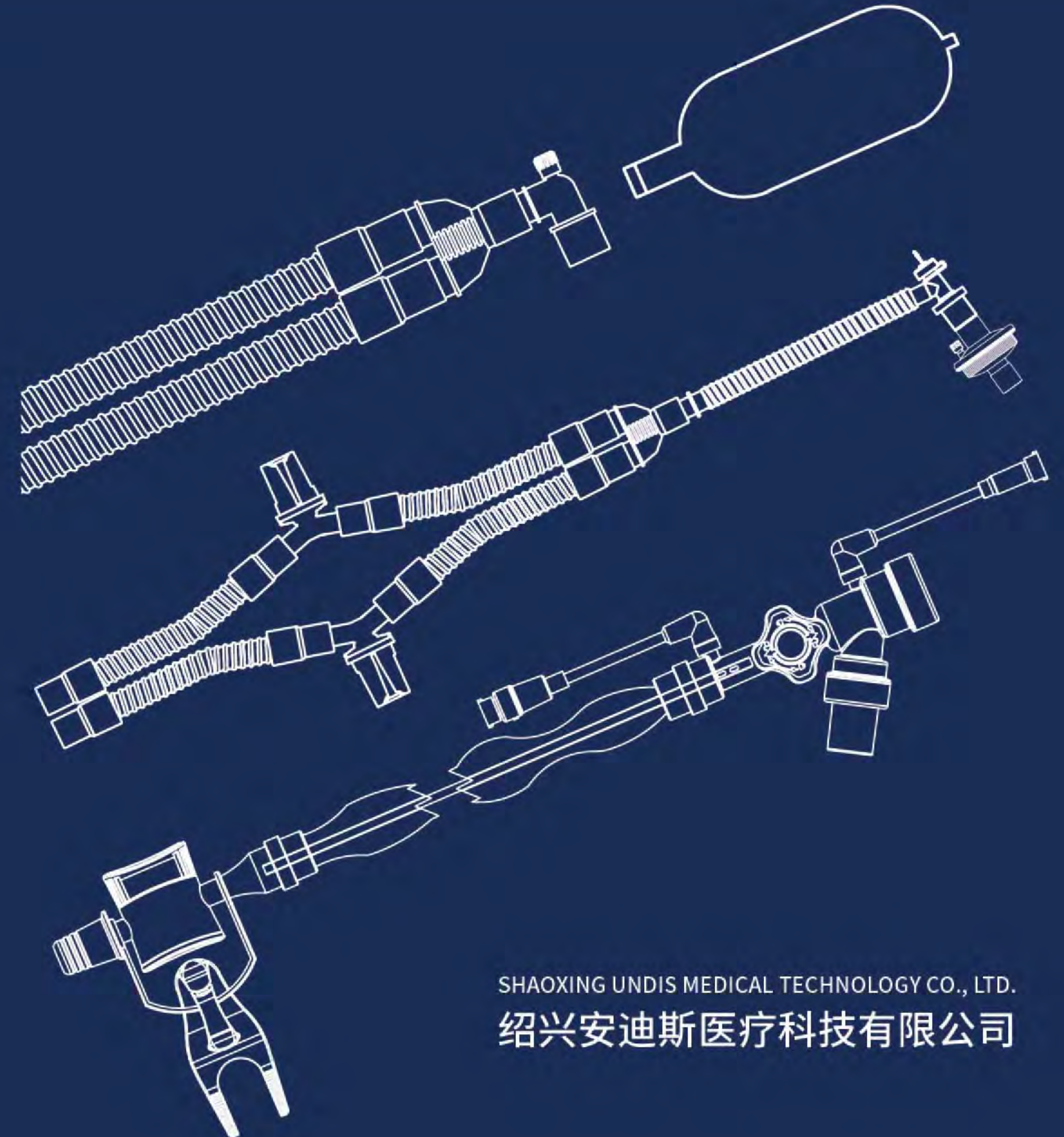

SHAOXING UNDIS MEDICAL TECHNOLOGY CO., LTD.

Add: No.12 Yuexing Technology Park, No.11 Fanrong Road, Binhai New Area, 312366 Shaoxing, Zhejiang Province, PEOPLE'S REPUBLIC OF CHINA

Tel: +86 575 85215008 / 85215007

Web: [www.undis.cn](http://www.undis.cn)

E-mail: [info@undis.cn](mailto:info@undis.cn)

SHAOXING UNDIS MEDICAL TECHNOLOGY CO., LTD.  
绍兴安迪斯医疗科技有限公司

# CONTENTS

<b>A</b>	<b>Company Profile</b>	01	<b>G</b>	<b>Manual Resuscitator</b>	21
				Adult, Pediatric, Neonatal	21
				Disposable and Reusable	21
<b>B</b>	<b>Ventilation System</b>	03	<b>H</b>	<b>Other products</b>	22
	Anesthesia circuit	03		Re-breathing bag	22
	Breathing circuit	04		Endotracheal intubation	23
	Single limb circuit	05		Yankauer suction	24
	Circuit with therapy	06		Guedel airway	25
	Heating Wire Circuit - Reusable and Disposable	07	<b>I</b>	<b>Accessories</b>	26
	Embedded heating wire circuit	08			
	CPAP/BPAP circuit	09			
	Reusable circuit	10			
<b>C</b>	<b>Catheter Mount</b>	11			
<b>D</b>	<b>Breathing Filters</b>	12			
	BVF	12			
	HMEF	13			
	HME, HPEA and other filters	14			
<b>E</b>	<b>Closed Suction System</b>	15			
	Adult, Pediatric, Neonatal	15			
	Tracheostomy, Endotracheal	15			
<b>F</b>	<b>Masks</b>	17			
	Anesthesia mask	17			
	CPAP mask	18			
	Oxygen mask	19			
	Nebulizer mask	20			

# A COMPANY PROFILE



ANESTHESIA  
BREATHING CIRCUIT

BREATHING  
FILTER

CATHETER  
MOUNT

ANESTHESIA  
MASK

CLOSED  
SUCTION SYSTEM

BREATHING  
BAG



Shaoxing Undis Medical Technology Co., Ltd is a leading manufacturer of respiratory and anesthesia products. We offer comprehensive portfolios including: Ventilation Circuits, Humidification system with heating wire circuit, Closed suction system, Anesthesia mask, Breathing Filter and combined HMEF as well as various components.

All products provided by Undis Medical are manufactured to the highest industry standards. ISO 13485 is just as much a part of our daily routine as the strictest adherence to the CFDA, CE, GMP Quality System Regulation.

We strive to offer products of real value that meet our customer's needs. Our continuous commitment is to the development of total solution for hospital, emergency and home environments.

All for Health, it's not only the slogan of Undis, but also our goal to provide best practice respiratory product solutions for patients and clinicians, offering quality, innovation and choice.

CE

ISO13485

CFDA

USFDA

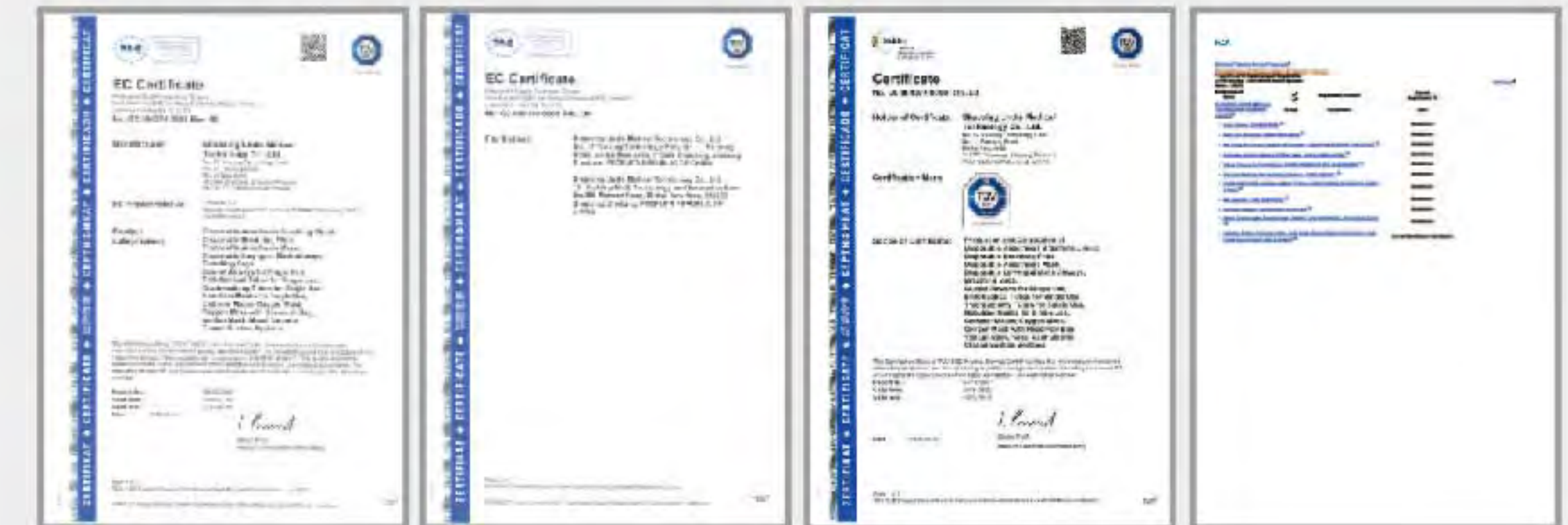

# B VENTILATION SYSTEM

## Anesthesia Circuit

Undis® offer a wide range of anesthesia circuits available in different lengths and configurations for anesthesiology, operating and recovery room.

- Low airflow resistance directly bonded connectors to the tube for avoiding leakage risks.
- Bio-compatible and Phthalates free material reduces allergy risk in patients.
- Tubing types: Corrugated, Expandable, Smoothbored.
- Standard 22mm/15mm/10mm connection meet ISO-5356-1.
- Optional accessories: Anesthesia Mask, Re-Breathing Bag, Filter, HMEF, Catheter Mount and etc.



## Breathing Circuit

Undis® offer a wide range of breathing circuits available in different lengths and configurations for anesthesiology, operating and recovery room.

- Low airflow resistance directly bonded connectors to the tube for avoiding leakage risks.
- Bio-compatible and Phthalates free material reduces allergy risk in patients.
- Tubing types: Corrugated, Expandable, Smoothbored.
- Standard 22mm/15mm/10mm connection meet ISO-5356-1.
- Optional accessories: Anesthesia Mask, Water trap, Filter, Catheter Mount and etc.

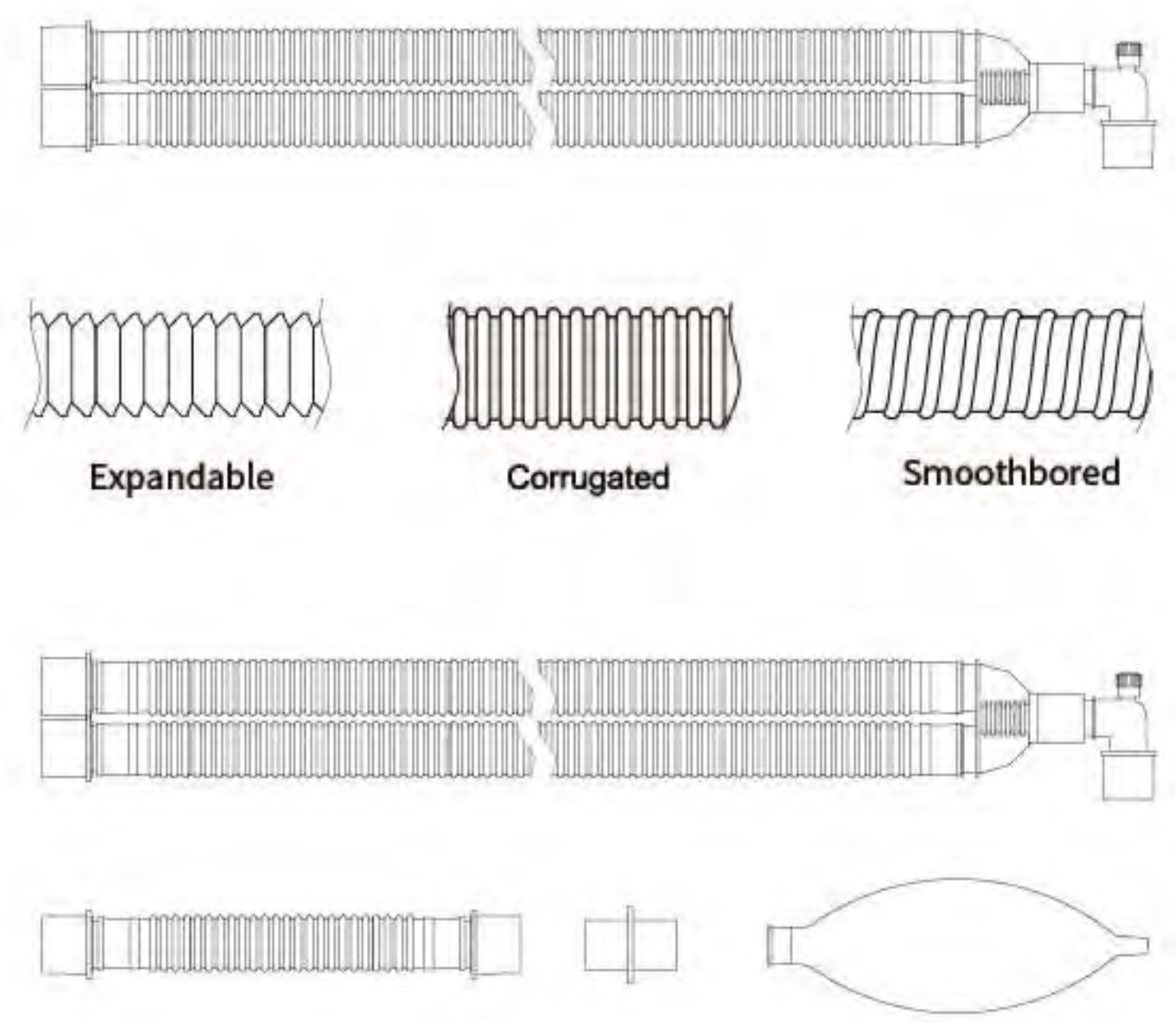

Corrugated circuit			
	Length	Item No.	Connection
Adult	180cm/70"	MZG-01-01	22mm
Pediatric	150cm/60"	MZG-01-02	15mm
Neonatal	150cm/60"	MZG-01-03	10mm

Expandable circuit			
	Length	Item No.	Connection
Adult	180cm/70"	MZG-02-01	22mm
Pediatric	150cm/60"	MZG-02-02	15mm

Smoothbored circuit			
	Length	Item No.	Connection
Adult	180cm/70"	MZG-03-01	22mm
Pediatric	150cm/60"	MZG-03-02	15mm

Corrugated circuit			
	Length	Item No.	Connection
Adult	180cm/70"	HXG-01-01	22mm
Pediatric	150cm/60"	HXG-01-02	15mm
Neonatal	150cm/60"	HXG-01-03	10mm

Expandable circuit			
	Length	Item No.	Connection
Adult	180cm/70"	HXG-02-01	22mm
Pediatric	150cm/60"	HXG-02-02	15mm

Smoothbored circuit			
	Length	Item No.	Connection
Adult	180cm/70"	HXG-03-01	22mm
Pediatric	150cm/60"	HXG-03-02	15mm

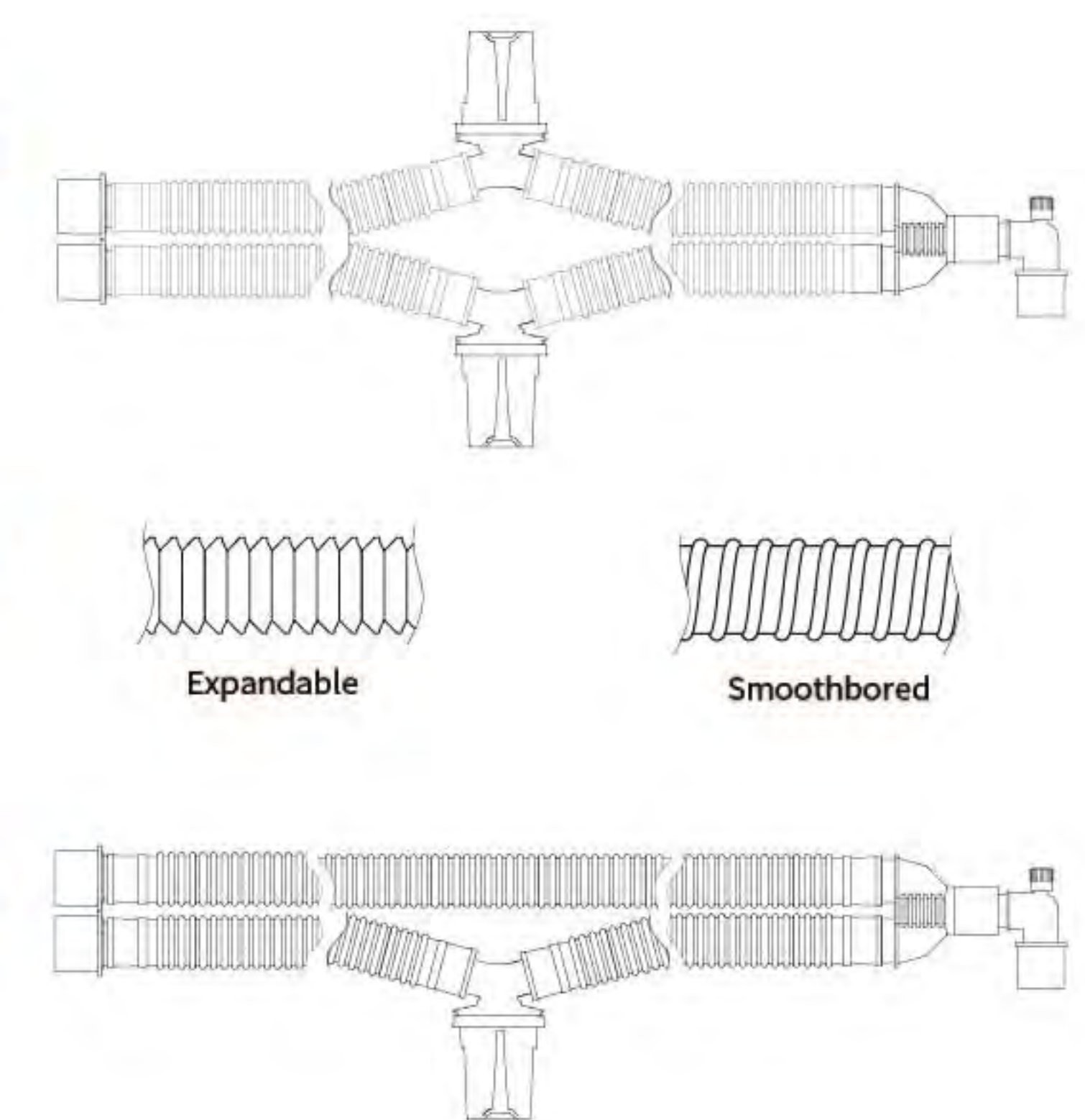

## Single limb circuit

Undis® offer vary kinds of single limb circuit for different applications.

- Less weight than dual limb circuit.
- All fittings comply with ISO 5356 standard.
- Low airflow resistance directly bonded connectors to the tube for avoiding leakage risks.
- Duo-limbo circuit, Coaxial circuit, IPPB circuit.



## Circuit with therapy

Undis® design for the patient need aerosol and MDI therapy without disconnect the tubing when doing ventilation.

- All fittings comply with ISO 5356 standard.
- Available to be connected with all sorts of anesthesia breathing circuit for therapy.
- Tubing types: Corrugated, Expandable, Smooth-bored. Include MDI, Nebulizer and Entonox Therapy.

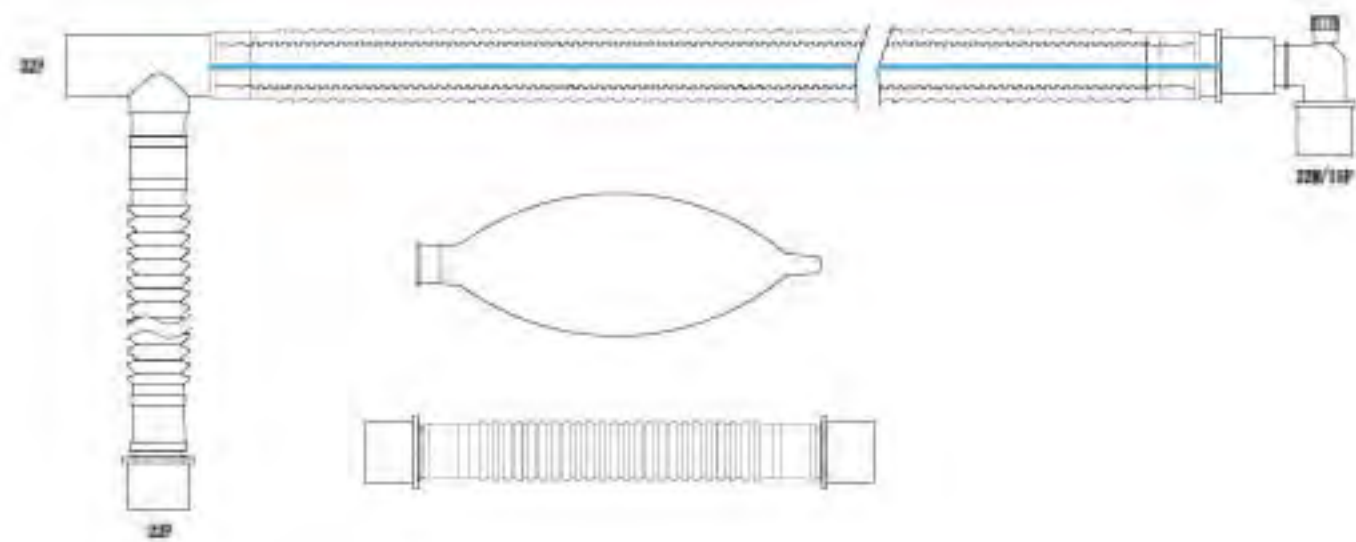

Duo limb circuit			
	Length	Item No.	Connection
Adult	180cm/70"	MZG-06-01	22mm
Remark	Unique design to avoid air leakage.		

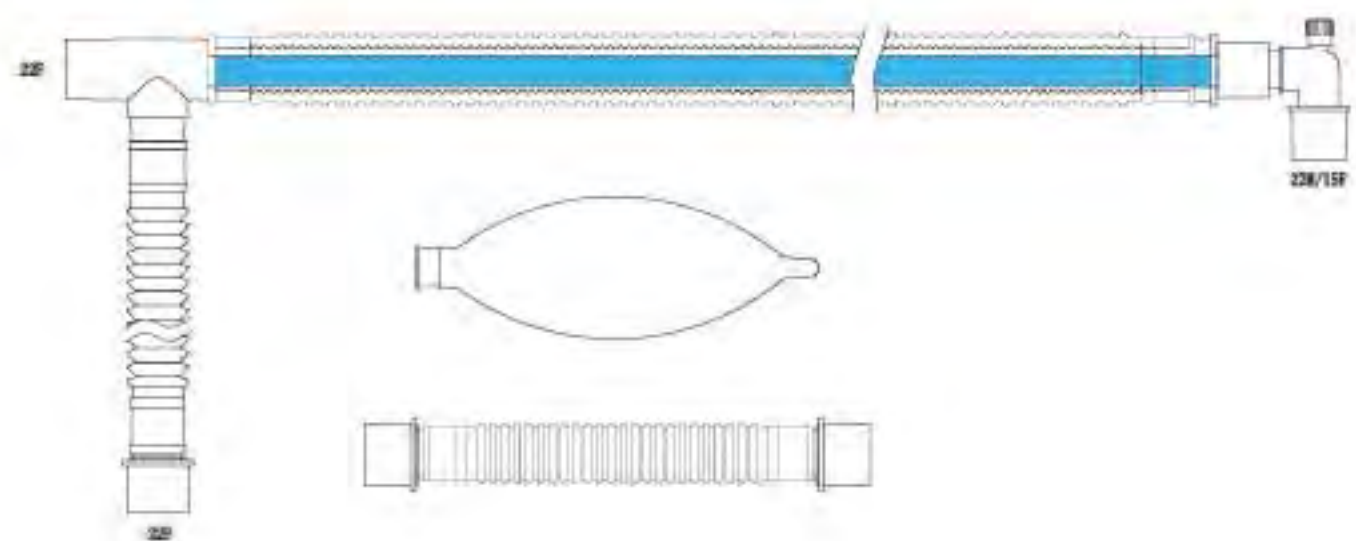

Coaxial and Expandable Coaxial circuit			
	Length	Item No.	Connection
Adult	180cm/70"	MZG-04-01	22mm
Pediatric	150cm/60"	MZG-04-02	15mm

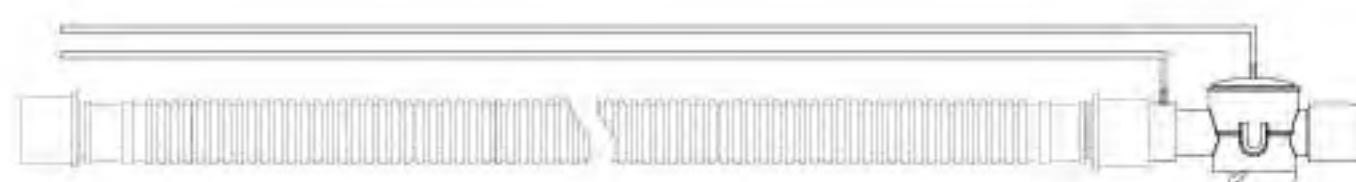

IPPB circuit			
	Length	Item No.	Connection
Adult	180cm/70"	MZG-05-01	22mm
Pediatric	150cm/60"	MZG-05-02	15mm
Neonatal	150cm/60"	MZG-05-03	15mm



Nebulizer therapy			
	Length	Item No.	Connection
Adult	180cm/70"	HXG-04-01	22mm
Pediatric	150cm/60"	HXG-04-02	15mm

MDI therapy			
	Length	Item No.	Connection
Adult	180cm/70"	HXG-04-01	22mm
Pediatric	150cm/60"	HXG-04-02	15mm
Neonatal	150cm/60"	HXG-04-03	10mm

Entonox circuit			
	Length	Item No.	Connection
Single limb	180cm/70"	HXG-05-01	22mm
Dual limb	180cm/70"	HXG-05-02	22mm

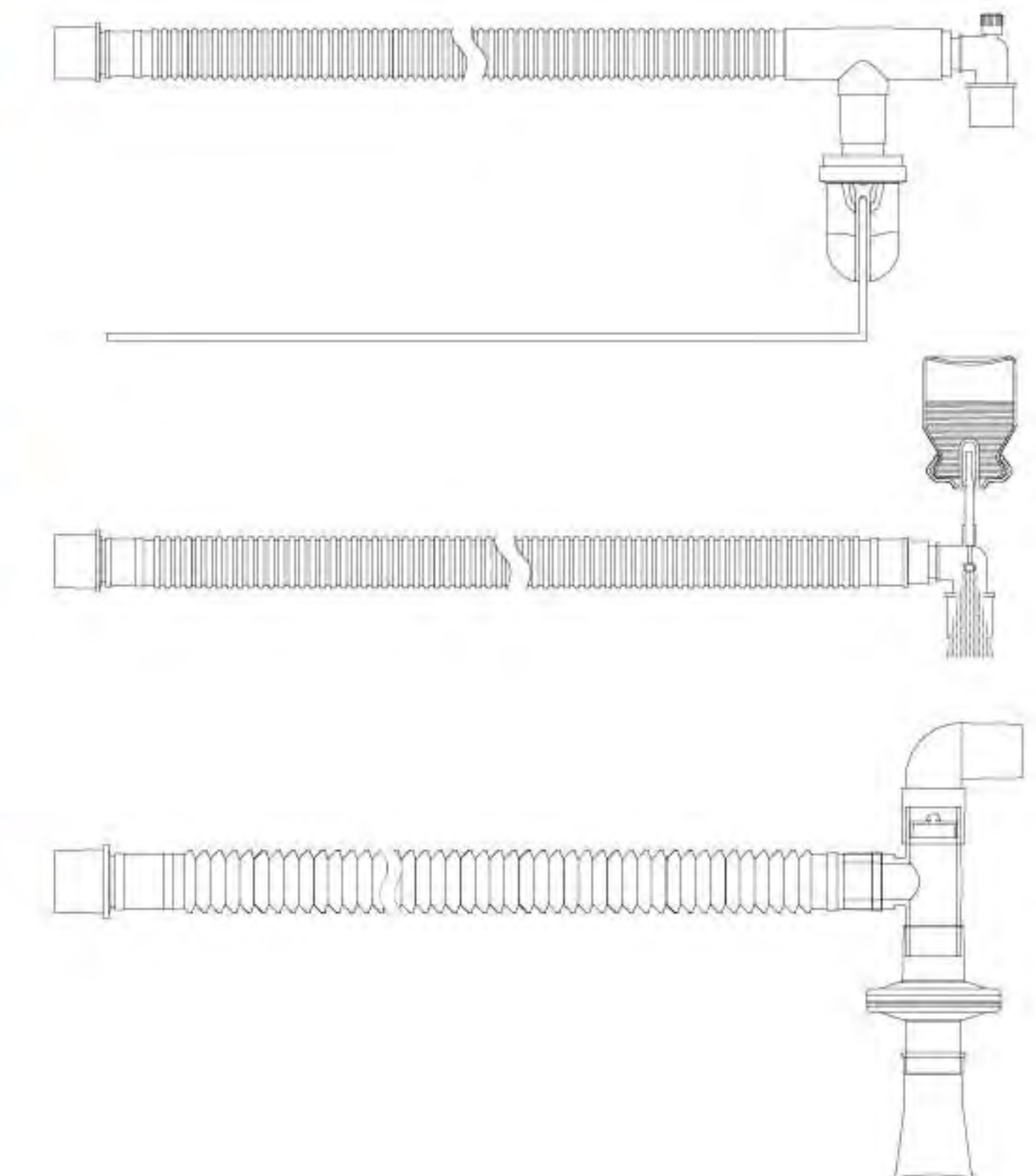

## Heating Wire Circuit – Reusable and Disposable

Undis® design for use together humidifier.

- Compatible with MR850 inspiratory.
- Minimizing condensate related ventilator alarms.
- Color identification: blue inspiratory limb, white expiratory limb.
- Available to be used in corrugated, smoothbored and CPAP tubing.
- Reusable one is available to autoclavable.



## Embedded heating wire circuit

Undis® design for use together humidifier.

- Minimizing condensate during humidification.
- Color identification: blue inspiratory limb, white expiratory limb.
- Low airflow resistance directly bonded connectors to the tube for avoiding leakage risks.

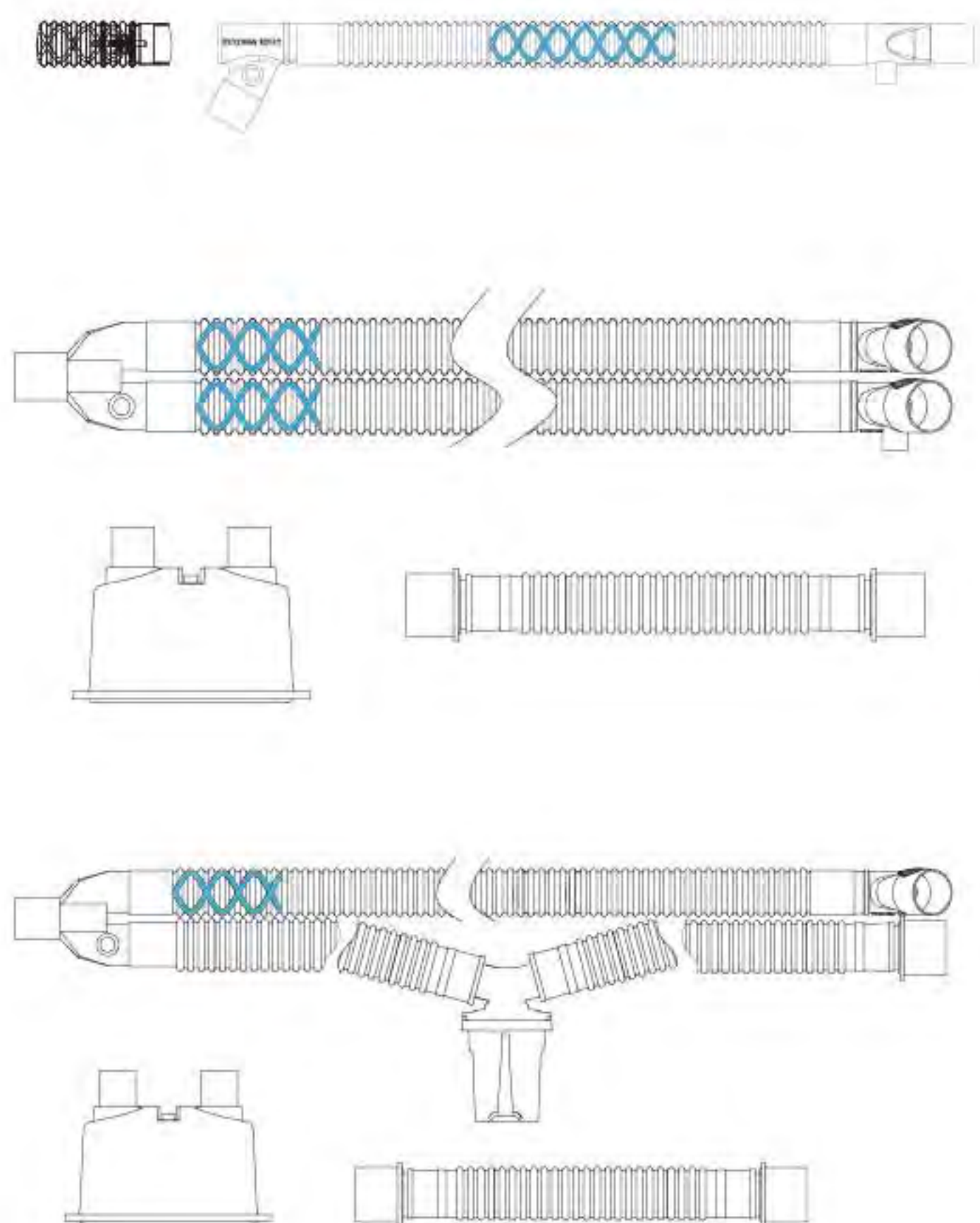

Dual Heating Wire			
	Length	Item No.	Connection
Adult	150cm/70"	HXG-06-01	22mm
Pediatric	120cm/47"	HXG-06-02	15mm
Neonatal	120cm/47"	HXG-06-03	15mm

Single Heating Wire			
	Length	Item No.	Connection
Adult	180cm/70"	HXG-06-04	22mm
Pediatric	150cm/60"	HXG-06-05	15mm
Neonatal	150cm/60"	HXG-06-06	10mm

Dual Heating Wire			
	Length	Item No.	Connection
Adult	150cm/70"	HXG-07-01	22mm
Pediatric	120cm/47"	HXG-07-02	15mm

Single Heating Wire			
	Length	Item No.	Connection
Adult	180cm/70"	HXG-07-03	22mm
Pediatric	150cm/60"	HXG-07-04	15mm

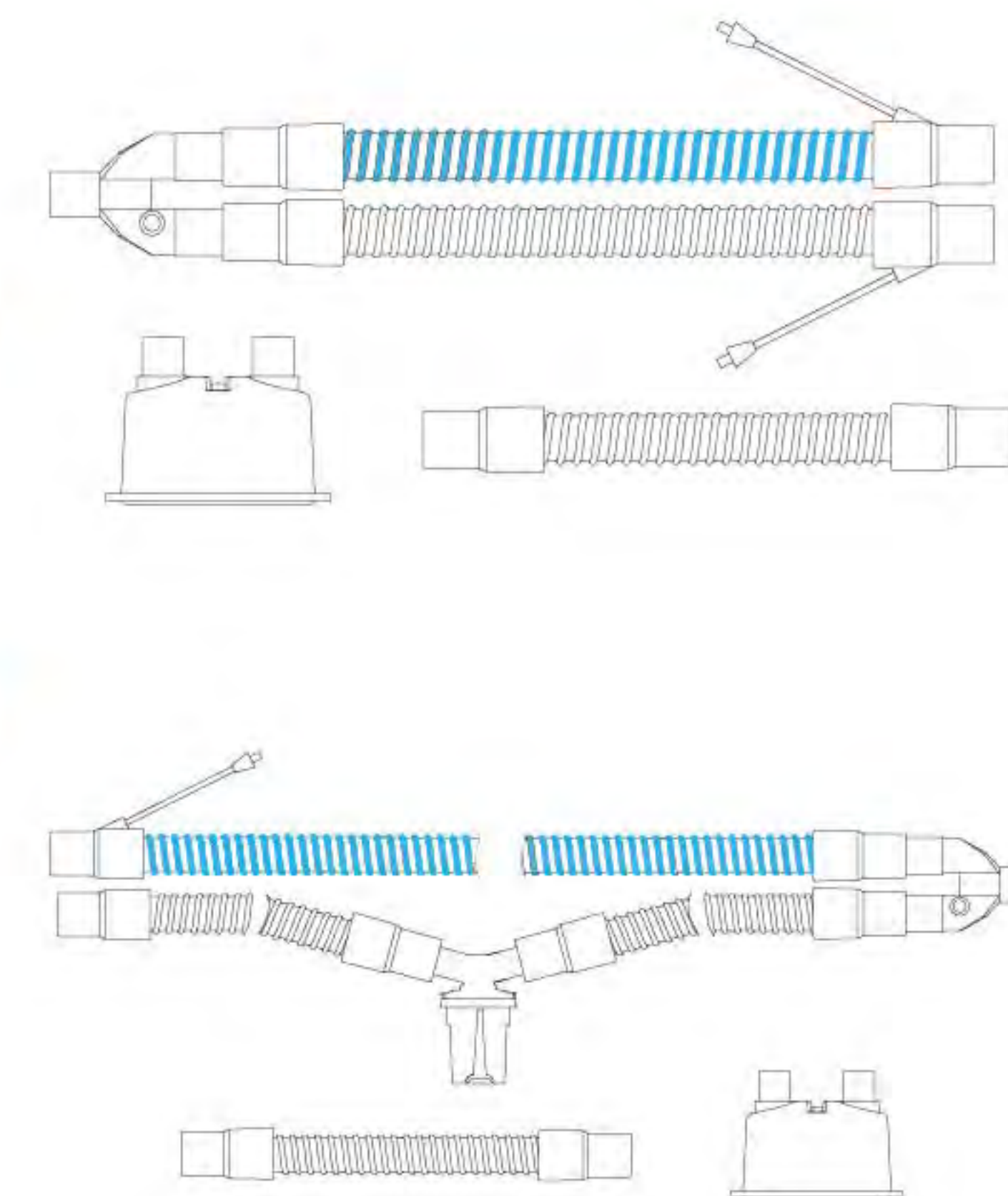

## CPAP/BPAP Circuit

Manufactured by Undis Med, CPAP is the method of ventilating a patient applying a higher pressure than environmental atmospheric pressure to the airways of the patient to improve oxygenation via ventilator or a CPAP machine.



## Reusable Circuit

Undis® offer a wide range of reusable anesthesia breathing circuits available in different lengths and configurations for anesthesiology, operating and recovery room.

- Low airflow resistance directly bonded connectors to the tube for avoiding leakage risks.
- Bio-compatible and Phthalates free material reduces allergy risk in patients.
- Standard 22mm/15mm/10mm connection meet ISO-5356-1.



Patient Circuit w/ Leakage			
	Length	Item No.	Connection
Adult	180cm/70"	HXG-08-03	22mm
Pediatric	150cm/60"	HXG-08-04	15mm

Reusable Breathing Circuit			
	Length	Item No.	Connection
Adult	150cm/70"	HXG-09-01	22mm
Pediatric	150cm/60"	HXG-09-02	15mm

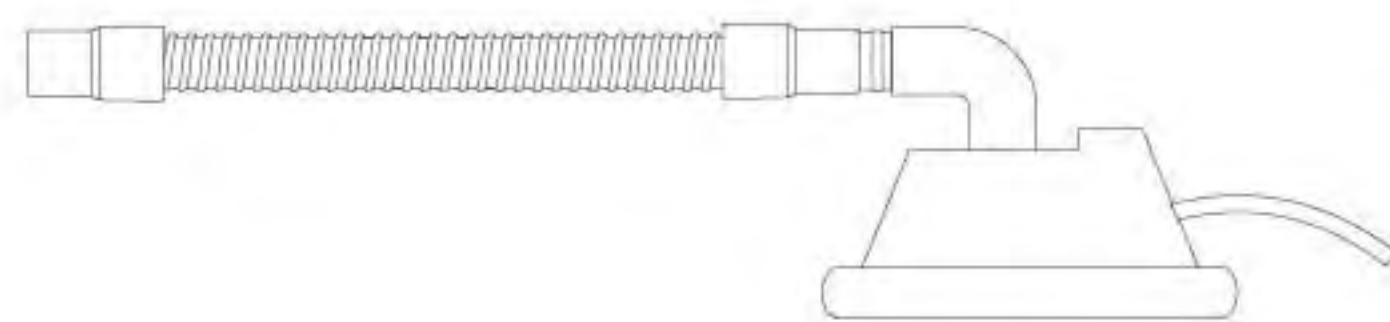

Reusable silicone mask with CPAP tubing			
	Length	Item No.	Connection
Adult	180cm/70"	HXG-08-04	22mm
Pediatric	150cm/60"	HXG-08-05	15mm

Reusable Breathing Circuit			
	Length	Item No.	Connection
Adult	150cm/70"	HXG-09-03	22mm
Pediatric	150cm/60"	HXG-09-04	15mm

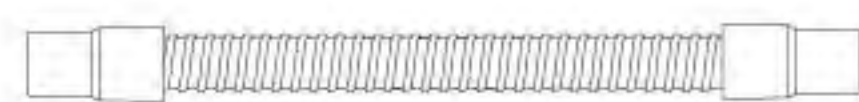

CPAP tubing			
	Length	Item No.	Connection
Adult	180cm/70"	HXG-08-01	22mm
Pediatric	150cm/60"	HXG-08-02	15mm

Reusable Single Limb			
	Length	Item No.	Connection
Adult	150cm/70"	HXG-09-05	22mm
Pediatric	150cm/60"	HXG-09-06	15mm



# C CATHETER MOUNT

Undis® range of catheter mount includes a wide choice of corrugated, expandable and smoothbored configurations.

- 360 degree double swivel elbow connector.
- Patent cap design to avoid air leakage.
- Luer lock port for gas sampling.
- ISO standard 22mm or 15mm adapters available.



# D BREATHING FILTERS

BVF

Dedicated to the quality, Undis® bacterial filters help minimize bacterial and viral particle penetration for use in anesthesia and intensive care.

- Low dead space to minimize the risk of re-breathing carbon dioxide.
- Luer lock port for gas sampling.
- ISO tapered connection to ensure secure connection without air leakage.
- H&V® filtration membrane to ensure high filtration efficiency up to 99.9999% with testing particle size ~3µm.
- Size: adult, pediatric.

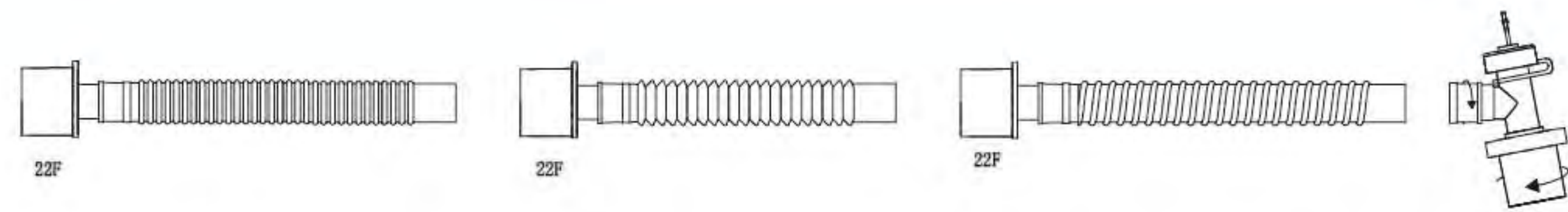

Corrugated tube	Expandable tube	Smoothbored tube	Double swivel Elbow Connector
Length 20cm/15cm	Length 20cm/15cm	Length 20cm/15cm	Connector 22M/15F
Dead space 35ml	Dead space 22~37ml	Dead space 27ml	Dead space 3ml

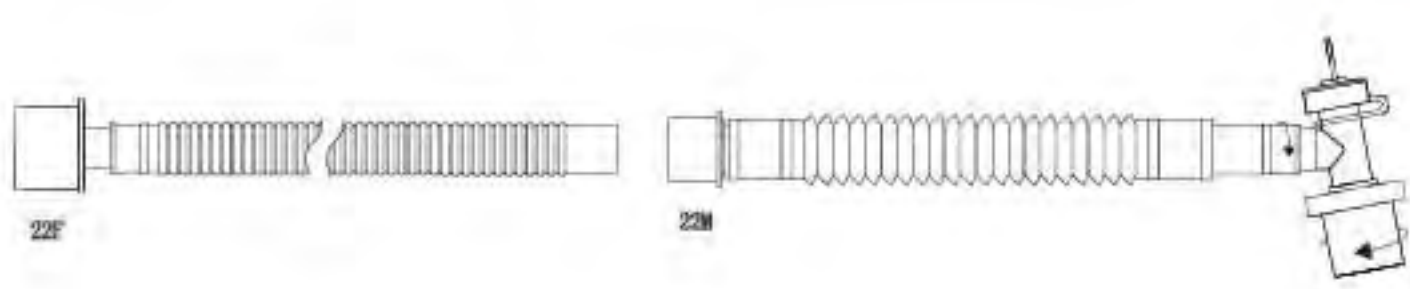

Corrugated tube		
Length	Item No.	Connection
20cm	YCG-01-01	22mm/15mm
15cm	YCG-01-02	22mm/15mm

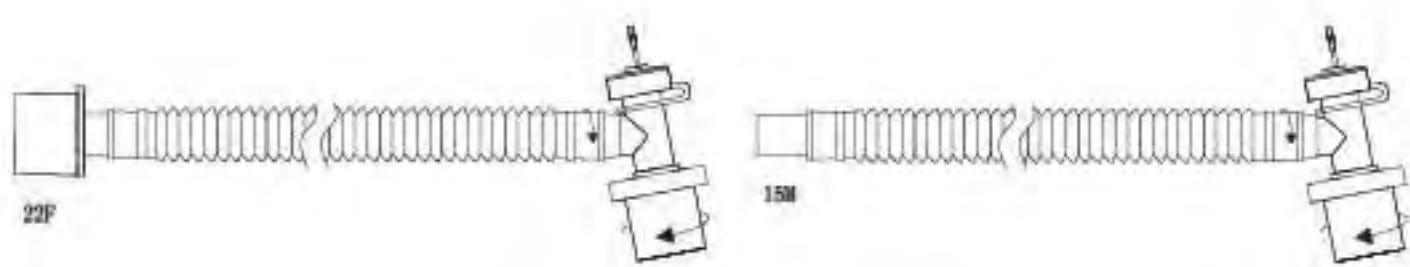

Expandable tube		
Length	Item No.	Connection
20cm	YCG-02-01	22mm/15mm
15cm	YCG-02-02	22mm/15mm

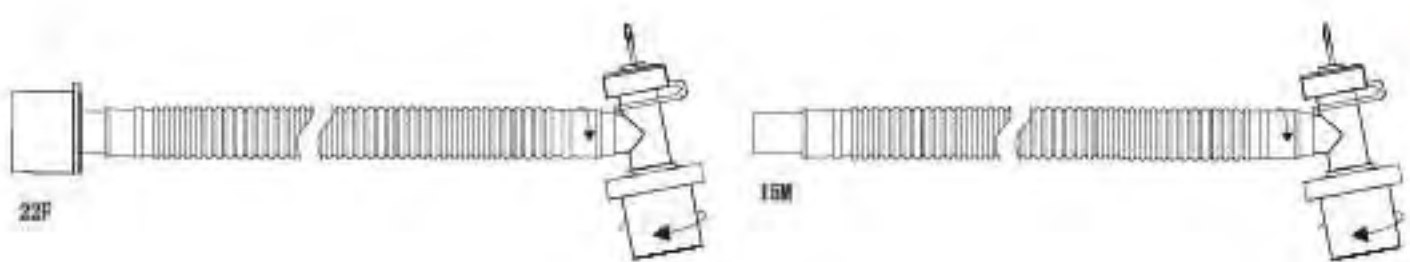

Smoothbored tube		
Length	Item No.	Connection
20cm	YCG-03-01	22mm/15mm
15cm	YCG-03-02	22mm/15mm



Products	Size	Efficiency	Connector	Dead space	Tidal Volume	Item No.
BVF-01	Adult	99.999%	22F-22M/15	20ml	200-1500ml	GLQ-01-01
BVF-02	Adult	99.999%	22F-22M/15	20ml	200-1500ml	GLQ-01-02
BVF-03	Adult	99.999%	22F-22M/15	20ml	200-1500ml	GLQ-01-03
BVF-04	Pediatric	99.999%	22F-22M/15	20ml	200-1500ml	GLQ-01-04
BVF-05	Pediatric	99.999%	22F-22M/15	17ml	100-300ml	GLQ-01-05
BVF-06	Adult	99.999%	22F-22M/15	17ml	100-300ml	GLQ-01-06

# HMEF

Undis® offer a completed range of HMEF with high filtration efficiency and moisture output for patient protection and humidification.

- Low dead space to minimize the risk of re-breathing carbon dioxide.
- Luer lock port for gas sampling.
- ISO tapered connection to ensure secure connection without air leakage.
- H&V® filtration membrane to ensure high filtration efficiency up to 99.99% with testing particle size ~3µm.
- High level moisture output up to 25mg@500VT.
- Size: adult, pediatric, neonatal.



# HME, HPEA and other filters

Undis® tracheostomy HME help to maximize the humidify with extremely low resistance and compatibility for the patient.

High level moisture output up to 24-25mg@500VT.



Products	Size	Efficiency	Moisture output	Connector	Dead space	Tidal Volume	Item No.
HMEF-01	Adult	99.999%	27mg@500VT	22M/15F-22F/15M	20ml	200-1500ml	GLQ-02-01
HMEF-02	Adult	99.999%	27mg@500VT	22F-22M/15F	12ml	200-1500ml	GLQ-02-02
HMEF-03	Pediatric	99.999%	27mg@500VT	22F-22M/15F	8ml	100-300ml	GLQ-02-03
HMEF-04	Neonatal	99.999%	27mg@500VT	15F-15M/8M	12ml	50-100ml	GLQ-02-04
HMEF-05	Adult	99.999%	27mg@500VT	22M/15F-22F/15M	15ml	200-1500ml	GLQ-02-05



Products	Name	Moisture output	Tidal Volume	Item No.
HME-01	Tracheostomy HME	25mg@500VT	200-1500ml	GLQ-03-01
HME-02		27mg@500VT	200-1500ml	GLQ-03-02
HME-03		26mg@500VT	200-1500ml	GLQ-03-03
HME-04	Artificial Nose	5 mg@500VT	75-1500ml	GLQ-03-04



Products	Efficiency	Connector	Resistance	Item No.
HEPA	99.9999%	22F-22M/15F	@30L/min:<0.2Kpa	GLQ-05-01
Spirometer-01	99.99%	Machine port (mm)ID 48; OD 29.50	@30L/min:<0.2Kpa	GLQ-05-02
Spirometer-02	99.99%	Machine port (mm) ID 25.0, 26.5, 29.5; OD 27.0, 29.50, 30.0, 30.5, 33.5	@30L/min:<0.2Kpa	GLQ-05-03

# E CLOSED SUCTION SYSTEM

CSS®

Closed Suction System

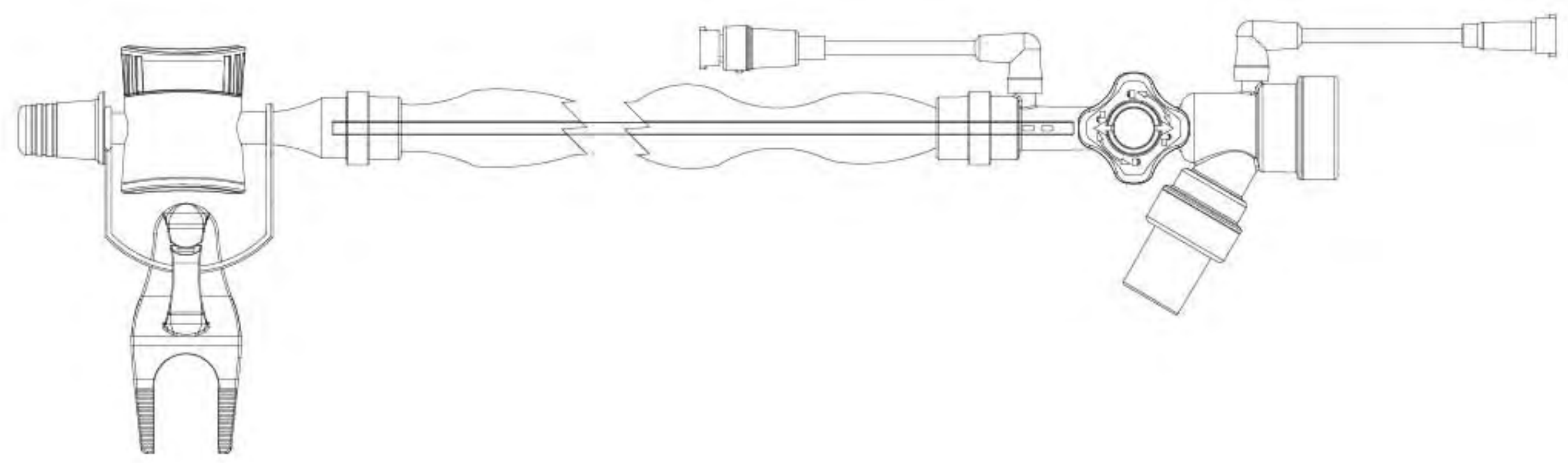
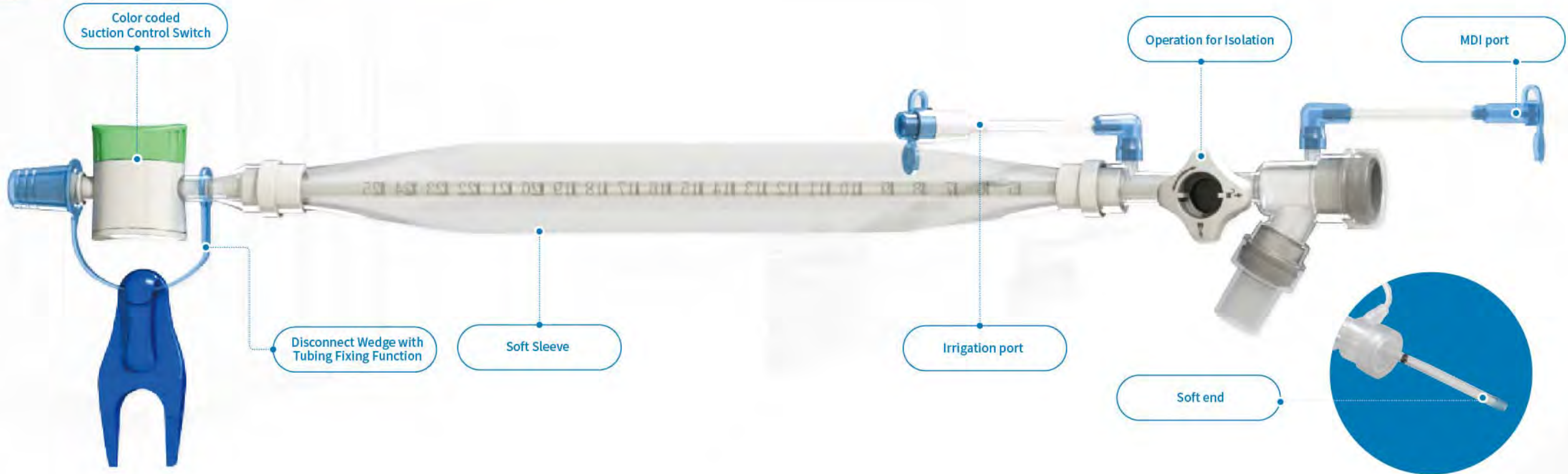

Outer Dia	Catheter length	Remark	Switch color
5Fr	300mm	Tracheostomy	Grey
	360mm	Endotracheal	Grey
6Fr	300mm	Tracheostomy	Grey
	360mm	Endotracheal	Grey
7Fr	300mm	Tracheostomy	Blue
	360mm	Endotracheal	Blue
8Fr	300mm	Tracheostomy	Yellow
	360mm	Endotracheal	Yellow
10Fr	300mm	Tracheostomy	Black
	550mm	Endotracheal	Black
12Fr	300mm	Tracheostomy	White
	550mm	Endotracheal	White
14Fr	300mm	Tracheostomy	Green
	550mm	Endotracheal	Green
16Fr	300mm	Tracheostomy	Orange
	550mm	Endotracheal	Orange
18Fr	300mm	Tracheostomy	Red
	550mm	Endotracheal	Red

- Available for 24Hour and 72Hours for all sizes Patent control switch, a “click” sound when fully turn on and turn off the switch.
- Catheter with soft tip and side holes.
- Color depth indicator.
- Dual swivel connector.

# F MASKS

A completed range of single use anesthesia masks, applicable with breathing and anesthesia circuits, manual resuscitator and other suitable medical gas ventilation.

- Completed range of sizes from adult, pediatric and neonatal. Color coded hook ring for size marked.
- Inflatable air cushion for better sealing.
- Bio-compatible material reduces allergy risk in patients.
- ISO standard connections.

## Anesthesia mask



## CPAP mask

Designed to provide a good seal when fitted to CPAP tubing and machine.

Available for both disposable and re-usable application.



Products	Size	Connector	Hook ring color	Item No.
	0# PRE-NEONATAL	15mm O.D.	N/A	MZM-02-01
	1# INFANT	15mm O.D.	N/A	MZM-02-02
	2# CHILD	22mm I.D.	Yellow	MZM-02-03
	3# SMALL ADULT	22mm I.D.	Pink	MZM-02-04
	4# MEDIUM ADULT	22mm I.D.	Green	MZM-02-05
	5# LARGE ADULT	22mm I.D.	Blue	MZM-02-06

Products	Size	Connector	Hook ring color	Item No.
	0# PRE-NEONATAL	15mm O.D.	white	MZM-01-01
	1# INFANT	15mm O.D.	Pink	MZM-01-02
	2# CHILD	22mm I.D.	Yellow	MZM-01-03
	3# SMALL ADULT	22mm I.D.	Blue	MZM-01-04
	4# MEDIUM ADULT	22mm I.D.	Red	MZM-01-05
	5# LARGE ADULT	22mm I.D.	Green	MZM-01-06

Products	Size	Connector	Hook ring color	Item No.
	1# INFANT	15mm O.D.	Pink	MZM-03-01
	2# CHILD	22mm I.D.	Yellow	MZM-03-02
	3# SMALL ADULT	22mm I.D.	Blue	MZM-03-03
	4# MEDIUM ADULT	22mm I.D.	Red	MZM-03-04

Full face	Size	Connector	Material	Item No.
	S	22mm O.D.	Silicone and PC	HXM-01-01
	M	22mm O.D.	Silicone and PC	HXM-01-02
	L	22mm O.D.	Silicone and PC	HXM-01-03

Nasal	Size	Connector	Material	Item No.
	M	22mm O.D.	Silicone and PC	HXM-02-01

Head gear	Size	Connector	Material	Item No.
	M	N.A	Nylon	TD-01

## Oxygen Mask

- Medical grade PVC (DEHP or DEHP free available).
- Medium concentration.
- Adjustable nose clip.
- Kinking free star lumen oxygen tube.
- Two colors for choice: green and transparent.



## Nebulizer mask

- Medical grade PVC (DEHP or DEHP free available).
- Medium concentration.
- Adjustable nose clip.
- Kinking free star lumen oxygen tube.
- Two colors for choice: green and transparent.

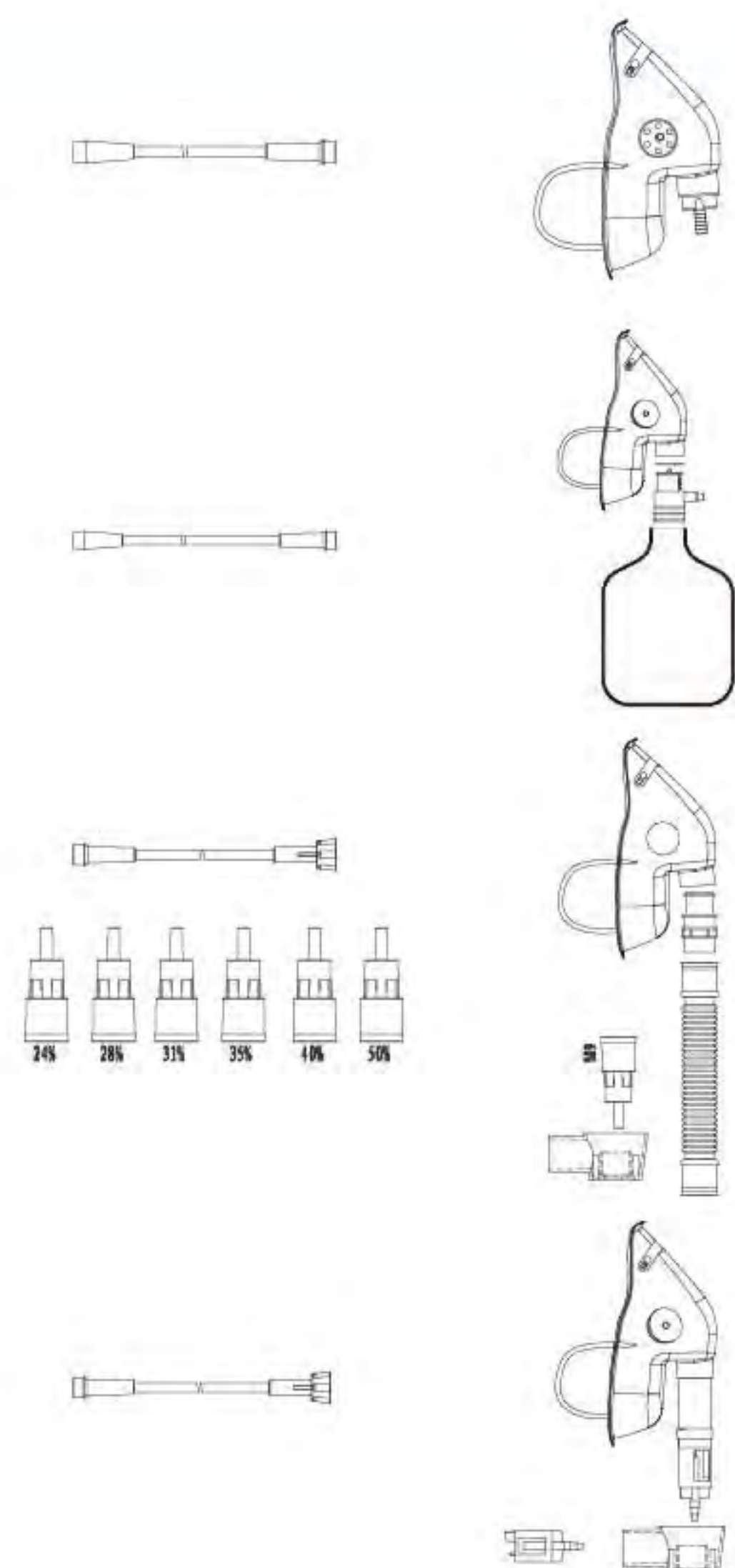

Type	Mask Size	Item No.
Oxygen mask	S	YQZ-01-01
	M	YQZ-01-02
	L	YQZ-01-03
	XL	YQZ-01-04

Type	Mask Size	Item No.
Non-rebreathing oxygen mask	S	YQZ-02-01
	M	YQZ-02-02
	L	YQZ-02-03
	XL	YQZ-02-04

Type	Mask Size	Item No.
Venturi mask	S	YQZ-03-01
	M	YQZ-03-02
	L	YQZ-03-03
	XL	YQZ-03-04

Type	Mask Size	Item No.
Adjustable Venturi mask	S	YQZ-04-01
	M	YQZ-04-02
	L	YQZ-04-03
	XL	YQZ-04-04

Type	Mask Size	Item No.
Nebulizer mask	S	WHQ-01-01
	M	WHQ-01-02
	L	WHQ-01-03
	XL	WHQ-01-04

Type	Mask Size	Item No.
Nebulizer Kit	T type	WHQ-02-01

Type	Mask Size	Item No.
Nebulizer Kit	135° type	WHQ-02-02

Type	Mask Size	Item No.
Tracheostomy mask(Nebulizer)	Adult	WHQ-03-01
	Child	WHQ-03-02

Type	Mask Size	Item No.
Tracheostomy mask(Oxygen)	Adult	WHQ-04-01
	Child	WHQ-04-02

# G MANUAL RESUSCITATOR

Undis® offer a wide range of manual resuscitator available in different configurations for emergency care.

- Equipped with pressure relief valve at 60/40/20 cmH2O with overridden mechanism.
- Two different materials of Silicone, and PVC for reuse or disposable.
- Three sizes available: adult, pediatric and infant. ISO standard connectors.
- Optional accessories: PEEP valve, Guedel airway and etc.



# H OTHER PRODUCTS

## Re-breathing bag



### Disposable Manual Resuscitator

	Volume	Item No.	Pressure relief
Adult	1650ml	FSQ-01-01	60cmH2O
Pediatric	600ml	FSQ-01-02	40cmH2O
Infant	300ml	FSQ-01-03	20cmH2O



### Reusable Manual Resuscitator

	Volume	Item No.	Pressure relief
Adult	1650ml	FSQ-02-01	60cmH2O
Pediatric	600ml	FSQ-02-02	40cmH2O
Infant	300ml	FSQ-02-03	20cmH2O



### CPR mask w/valve

	Item No.	One way valve
Adult, Pediatric	FSQ-03-01	Yes



Type	Mask Size	Item No.
Latex Breathing Bag	0.5 L	HXN-01-01
	1.0 L	HXN-01-02
	2.0 L	HXN-01-03
	3.0 L	HXN-01-04

Type	Mask Size	Item No.
Latex free Breathing Bag	0.5 L	HXN-02-01
	1.0 L	HXN-02-02
	2.0 L	HXN-02-03
	3.0 L	HXN-02-04

Type	Mask Size	Item No.
Silicone Breathing Bag	1.0 L	HXN-03-01
	2.0 L	HXN-03-02
	3.0 L	HXN-03-03

Type	Mask Size	Item No.
Test lung	1.0 L	PN-04-01

## Endotracheal intubation



Type	Size(mm)	Item No.	Size(mm)	Item No.	Size(mm)	Item No.
Endotracheal Tube Uncuffed QCG-01	2.0	QCG-01-01	5.0	QCG-01-07	8.0	QCG-01-13
	2.5	QCG-01-02	5.5	QCG-01-08	8.5	QCG-01-14
	3.0	QCG-01-03	6.0	QCG-01-09	9.0	QCG-01-15
	3.5	QCG-01-04	6.5	QCG-01-10	9.5	QCG-01-16
	4.0	QCG-01-05	7.0	QCG-01-11	10.0	QCG-01-17
	4.5	QCG-01-06	7.5	QCG-01-12	-	-



Type	Size(mm)	Item No.	Size(mm)	Item No.	Size(mm)	Item No.
Reinforced Endotracheal Tube Uncuffed QCG-02	2.0	QCG-02-01	5.0	QCG-02-07	8.0	QCG-02-13
	2.5	QCG-02-02	5.5	QCG-02-08	8.5	QCG-02-14
	3.0	QCG-02-03	6.0	QCG-02-09	9.0	QCG-02-15
	3.5	QCG-02-04	6.5	QCG-02-10	9.5	QCG-02-16
	4.0	QCG-02-05	7.0	QCG-02-11	10.0	QCG-02-17
	4.5	QCG-02-06	7.5	QCG-02-12	-	-



Type	Size(mm)	Item No.	Size(mm)	Item No.	Size(mm)	Item No.
Endotracheal Tube Cuffed QCG-03	2.0	QCG-03-01	5.0	QCG-03-07	8.0	QCG-03-13
	2.5	QCG-03-02	5.5	QCG-03-08	8.5	QCG-03-14
	3.0	QCG-03-03	6.0	QCG-03-09	9.0	QCG-03-15
	3.5	QCG-03-04	6.5	QCG-03-10	9.5	QCG-03-16
	4.0	QCG-03-05	7.0	QCG-03-11	10.0	QCG-03-17
	4.5	QCG-03-06	7.5	QCG-03-12	-	-



Type	Size(mm)	Item No.	Size(mm)	Item No.	Size(mm)	Item No.
Reinforced Endotracheal Tube Cuffed QCG-04	2.0	QCG-04-01	5.0	QCG-04-07	8.0	QCG-04-13
	2.5	QCG-04-02	5.5	QCG-04-08	8.5	QCG-04-14
	3.0	QCG-04-03	6.0	QCG-04-09	9.0	QCG-04-15
	3.5	QCG-04-04	6.5	QCG-04-10	9.5	QCG-04-16
	4.0	QCG-04-05	7.0	QCG-04-11	10.0	QCG-04-17
	4.5	QCG-04-06	7.5	QCG-04-12	-	-



Type	Size(mm)	Item No.	Size(mm)	Item No.
Laryngeal Mask Airway PVC	1.0	HZ-01-01	3.0	HZ-01-05
	1.5	HZ-01-02	4.0	HZ-01-06
	2.0	HZ-01-03	5.0	HZ-01-07
	2.5	HZ-01-04	-	-



Type	Size(mm)	Item No.	Size(mm)	Item No.
Reinforced LMA PVC	1.0	HZ-02-01	3.0	HZ-02-05
	1.5	HZ-02-02	4.0	HZ-02-06
	2.0	HZ-02-03	5.0	HZ-02-07
	2.5	HZ-02-04	-	-



Type	Size(mm)	Item No.	Size(mm)	Item No.
Reusable LMA Silicone	1.0	HZ-03-01	3.0	HZ-03-05
	1.5	HZ-03-02	4.0	HZ-03-06
	2.0	HZ-03-03	5.0	HZ-03-07
	2.5	HZ-03-04	-	-

## Suction catheter



- Medical-grade PVC (DEHP or DEHP free available)
- With lumen suctioning secretions accumulated under cuff

Type	Item No.				Size (FR/CH)	Color coding
	Plain type	T type	Cap-on type	T type		
Suction Catheter	XTG-02-01	XTG-03-01	XTG-04-01	XTG-05-01	6	Light green
	XTG-02-02	XTG-03-02	XTG-04-02	XTG-05-02	8	Blue
	XTG-02-03	XTG-03-03	XTG-04-03	XTG-05-03	10	Black
	XTG-02-04	XTG-03-04	XTG-04-04	XTG-05-04	12	White
	XTG-02-05	XTG-03-05	XTG-04-05	XTG-05-05	14	Green
	XTG-02-06	XTG-03-06	XTG-04-06	XTG-05-06	16	Orange
	XTG-02-07	XTG-03-07	XTG-04-07	XTG-05-07	18	Red
	XTG-02-08	XTG-03-08	XTG-04-08	XTG-05-08	20	Yellow

- Medical-grade PVC (DEHP or DEHP free available)
- With lumen suctioning secretions accumulated under cuff

Type	Size(FR/CH)	Item NO.	Size(FR/CH)	Item NO.
Stomach tube PVC	6	WG-01-01	16	WG-01-06
	8	WG-01-02	18	WG-01-07
	10	WG-01-03	20	WG-01-08
	12	WG-01-04	22	WG-01-09
	14	WG-01-05	24	WG-01-10

## Stomach tube PVC



- Medical-grade PVC (DEHP or DEHP free available)
- With lumen suctioning secretions accumulated under cuff

Type	Size		Item NO.
Yankauer suction handle	Flat tip	Without	YKG-01-01
	Flat tip	With	YKG-01-02
	Crown tip	Without	YKG-01-03
	Crown tip	With	YKG-01-04

## Yankauer suction handle



## Suction connecting tube



- Medical-grade PVC (DEHP or DEHP free available).
- With lumen suctioning secretions accumulated under cuff.

Type	Size		Item No.	Remark
Suction Connecting Tube	Flat tip	Without	YKG-02-01	Length can be customized
	Flat tip	With	YKG-02-02	
	Crown tip	Without	YKG-02-03	
	Crown tip	With	YKG-02-04	

## Guedel Airway



- Color coded for easy identification of sizes.
- Made of polypropylene.
- With reinforcement insert.

Type	Size(mm)	Item No.	Size(mm)	Item No.
Gudeel Airway	50	KYD-02-01	90	KYD-02-05
	60	KYD-02-02	100	KYD-02-06
	70	KYD-02-03	110	KYD-02-07
	80	KYD-02-04	120	KYD-02-08

## Nasopharyngeal Airway



- For nasal airway ventilation only.
- Color available with Green, blue and white semi-transparent.

Type	Size(mm)	Item No.	Size(mm)	Item No.	Size(mm)	Item No.
Nasopharyngeal Airway	2.5	BYD-01-01	5.0	BYD-01-06	7.5	BYD-01-11
	3.0	BYD-01-02	5.5	BYD-01-07	8.0	BYD-01-12
	3.5	BYD-01-03	6.0	BYD-01-08	8.5	BYD-01-13
	4.0	BYD-01-04	6.5	BYD-01-09	9.0	BYD-01-14
	4.5	BYD-01-05	7.0	BYD-01-10	-	-

# I ACCESSORIES

## | Elbow connector |



WT-01  
22M/15F-15M



WT-02  
22M/15F-15M



WT-03  
22M/15F-15M



WT-04 MDI  
22M/15F-15M



WT-05  
22M/15F-15M



WT-06  
22M-15M



WT-07  
Φ5.8mm

## | THREE-WAY CONNECTOR |



ST-01  
15F/22M-22Mx2



ST-02  
15F/22M-22Mx2



ST-03  
15F/22M-22Mx2



ST-04  
15F/22M-22Mx2



ST-05  
15F/22M-22Mx2



ST-06  
15F/22M-22Mx2



ST-07  
15F/22M-15x2



ST-08  
10Mx2-22M/15F



ST-09  
22M-22M-22M



ST-10  
18F-22M-22F/25M



ZT-14  
15F/22M-15M



ZT-15  
15M-22F



ZT-16  
15M-15F



ZT-17  
15M-15M



ZT-18  
15F/22M-22M

| Straight connector |



ZT-01  
15M-22F



ZT-02  
19M-22F



ZT-03  
22M-22F



ZT-04  
10M-15F



ZT-05  
22M-22M/15F



ZT-06  
10M-15F



ZT-07  
10M-22F



ZT-09  
22M-22M



ZT-10  
22M-22F



ZT-11  
15F/22M-22M



ZT-12  
15M-15M



ZT-13  
15F/22M-22F/15M

| Others |



JSB-01, JSB-02, JSB-03  
Adult, Pediatric, Infant



MF-01  
Manifold



MF-02  
Manifold



NC-01  
Nose Clip



AQM-01  
Catheter mount



AQM-02  
Luer cap



AQM-03  
Anti dust



KH-01



KH-02



CO2 sampling line



Humidification  
chamber



PEEP Valve